



powerstar so-LO™

THE SUPER LOW LOSS, SMART TRANSFORMER

AMORPHOUS CORE DISTRIBUTION TRANSFORMERS WITH
REMOTE MONITORING CAPABILITIES

THE ONLY AMORPHOUS CORE DISTRIBUTION TRANSFORMER DESIGNED AND MANUFACTURED IN THE UK



WHY AMORPHOUS?

HISTORIC TRANSFORMERS

At the time of its advent, the traditional distribution transformer was made of carbon steel. This evolved to silicon steel and eventually to the cold rolled grain oriented silicon steel (CRGO) laminations that make up the average present day traditional transformer. Due to transformers being used for long periods of time, with an average estimated lifespan of 30-40 years, it has always been essential that the materials used can withstand the test of time.

Due to an increased interest in producing more sustainable and environmentally friendly equipment in line with the global movement of environmental protection; pressure and demand for a solution which offers improved energy savings has been a key issue. Inevitably, materials which exhibit the qualities of low core loss and low magnetostriction, such as amorphous alloy, have been a particular point of interest.

AMORPHOUS ALLOY CORE

From the outset, amorphous alloy core is a more efficient material as its properties include low core loss and low magnetostriction, meaning load and no load losses in transformers that utilise this core are reduced. This is due to the internal structure of the material which is more flexible than CRGO, meaning that easy magnetisation and demagnetisation can take place. The ability to switch magnetisation at a quicker rate than its conventional CRGO counterpart delivers the lower losses.

It has been widely researched and findings show that amorphous core transformers provide a super low core loss alternative to conventional transformers whilst providing higher efficiencies, longevity, and low magnetising current. The amorphous core transformer is a well known and mature product that has been proven to be reliable.

BASIC PARAMETERS	AMORPHOUS METAL	CRGO
Strip Thickness (mm)	0.025	0.18 - 0.35
Density (gr/cm ³)	7.18	7.65

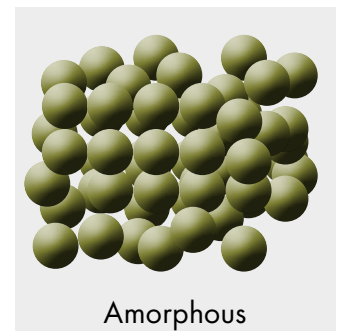
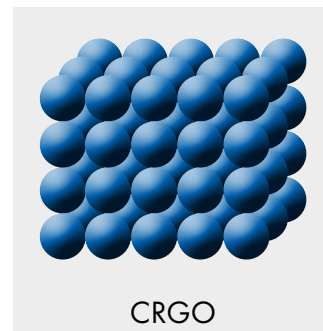

Due to the atomic structure and the thickness of the amorphous metal material higher efficiency can be achieved, in addition to CO₂ emission reductions achieved through saving energy.

It is the random pattern of the amorphous atom that allows for lower resistance to magnetisation cycles and delivers lower core losses.

WHY AMORPHOUS?

The super low loss amorphous core present in the UK manufactured Powerstar **SO-LO** smart transformers deliver the highest efficiencies and reduce the amount of unnecessary losses which equates to savings on operating costs and reductions in CO₂ emissions.

The **SO-LO** amorphous metal distribution transformer (AMDT) contributes to improving site resilience and can help protect against issues in the grid supply voltage, such as fluctuations. It allows for HV infrastructure upgrades to be carried out in a cost effective way with minimal disruption to operations, a big advantage for many commercial sites.

THE DIFFERENCE AT THE CORE OF THE SOLUTION...

Due to the molecular structure of the amorphous core found within the Powerstar **SO-LO** smart transformer, it exceeds the 2021 EU Ecodesign Directive Standards, which are illustrated in the tables below. This is due to the random pattern that the metal atoms form compared to the rigid structure found within silicon steel, combined with a ribbon thickness of only 0.025mm, and high electrical resistivity, it allows for lower hysteresis losses because less energy is wasted during the magnetisation and demagnetisation cycles of the supply current.

RATED POWER (kVA)	CONVENTIONAL CRGO DISTRIBUTION TRANSFORMER			2021 EU ECODSIGN DIRECTIVE STANDARDS		
	Load Losses [W]	No Load Losses (core losses) [W]	Impedance [%]	Load Losses [W]	No Load Losses (core losses) [W]	Impedance [%]
315	5,000	770	4	2,800	324	4
500	7,200	1,000	4	3,900	459	4
800	10,500	1,400	6	4,600	585	4.5
1,000	13,000	1,700	6	7,600	693	4.5
1,600	20,000	2,600	6	12,000	1,080	4.5
2,000	26,000	3,100	6	15,000	1,305	5
2,500	32,000	3,500	6	18,500	1,575	5

COMPARISON OF TESLA RATINGS

SO-LO Tesla Rating	Typical European Tesla Rating	Typical Overseas Tesla rating
1.2 – 1.3	1.65 – 1.70	1.65 – 1.70



If your site has a unique specification, contact one of our specialists today to find out how we can maximise your efficiencies with our range of solutions.



SECURING THE SUPPLY OF YOUR SITE

The **SO-LO** amorphous core smart transformers provide a cost effective way of reducing your energy consumption by upgrading your HV infrastructure.



FEATURES

- 36 month warranty*
- Bespoke solution to meet client's requirements
- Simple upgrade to HV infrastructure that can provide energy and cost savings
- Meets and surpasses 2021 EU Ecodesign Directive standards set by European Commission
- Dedicated customer service 24/7, 365 days a year
- Experienced UK manufacturer of quality amorphous core transformers
- Variety of fittings and applications to suit every site



BENEFITS

- Up to 75% lower core losses compared to CRGO transformers
- Delivers greater consumption savings, on average, compared to traditional CRGO transformers
- Contributes towards CSR by reducing CO₂ emissions
- Simple non-invasive energy efficiency system
- Gain instant energy consumption savings
- Remote monitoring allows for greater visibility of transformers operations
- Reduce operating costs
- Expected lifespan of up to 50 years

Powerstar meets the highest quality standards including UL Quality Assurance (E472553), Quality Assurance ISO 9001:2015 (FS579032) and Environmental Management ISO 14001:2015 (EMS600861).

View our full list of accreditations at www.powerstar.com/awards

Meets and surpasses **2021 EU Ecodesign Directive** standards set by the European Commission



*Warranty applies to systems installed within the UK.

Warranty will be voided if annual maintenance performance inspections are not undertaken.

Powerstar offers a complete range of maintenance services, contact us today or visit

Powerstar.com/maintenance to learn more.



CUSTOMISATIONS, APPLICATIONS & PROCESSES

We understand every customer has different needs, so we provide a number of fittings and accessories to maximise the impact of **SO-LO** on your site. Below shows an example of the most popular applications and fittings.

POPULAR SECTORS



Manufacturing



Telecoms



Retail



Healthcare



Commercial



Industrial

POPULAR FITTINGS

- | | | |
|--|--|--|
| <ul style="list-style-type: none"> • Radiator valves • Bi-directional rollers • Dehydrating breather • AVR relay and control panel | <ul style="list-style-type: none"> • Winding temperature indicator • Close coupled MV switchgear • Close coupled LV cabinets/feeder pillars | <ul style="list-style-type: none"> • Pressure relief device • Marshalling box • Forced air cooling • Oil temperature indicator |
|--|--|--|

POPULAR APPLICATIONS



Wind farms increasing plant output



Conventional transformer upgrades



Solar (PV) farms



Isolation transformers



Step up and step down transformers



Voltage management

Whilst Powerstar **SO-LO** is a 11kV to 415V amorphous core smart distribution transformer, as manufacturers we can provide a variety of bespoke amorphous core solutions including:

SO-LO BESPOKE SOLUTIONS

- | | |
|--|---|
| <ul style="list-style-type: none"> • Single phase transformers • Three phase transformers • ONAN, KNAN & AN transformers • Incoming voltages up to 33,000 volts • On-load or off-load tap changes • Liquid filled or dry type • Dual voltages | <ul style="list-style-type: none"> • Standard specifications • Bespoke specifications • Corrugated or bolt on radiator tanks • Adjustable tapping range -5% to +5% • Typical primary voltages:
3.3kV, 6.6kV, 11kV, 11-6.6kV DUAL, 33kV • Typical secondary voltages:
280V, 315V, 400V, 415V, 433V, 480V, 690V |
|--|---|



TAPPING INTO ADDITIONAL SAVINGS...

VOLTAGE MANAGEMENT



WHAT'S THE PROBLEM?

Historically, the electricity network within the UK was required to provide voltage to a building inside the range of 225V and 254V. This outdated measure has resulted in the majority of facilities still being supplied with voltages higher than 242V, despite most electrical equipment in the UK operating optimally at around 220V and regardless of the introduction of new quality and supply regulations aimed at combating this issue.

The oversupply of voltage results in inflated electricity prices, higher electricity consumption, high levels of carbon emissions, and unnecessary wear and tear to voltage dependent on-site equipment.

Voltage management through a site's distribution network can help to alleviate this issue by reducing the unnecessary voltage supplied to a site through the HV infrastructure, reducing the overvoltage before it reaches the LV infrastructure, this can be achieved without the installation of additional equipment resulting in a minimised plant footprint.

A COMBINED SOLUTION, MAXIMUM BENEFITS



Replacing an existing distribution transformer with an amorphous core distribution transformer can instantly yield efficiency benefits. However, further benefits can be achieved through the use of an extended tapping range, which can reduce the unnecessarily high voltage down to between 230V-220V, depending on a site's requirements and available supply.

To deliver the most efficient supply to certain loads, a transformer's rated voltage may need to be raised or lowered. This is managed through the addition or subtraction of portions of a winding, which in turn changes the transformer turn ratio and alters the supply the site receives.

A standard **SO-LO** amorphous core smart transformer has 5 tap settings, although as each system is built bespoke, this can be adjusted to suit the client. Any of these 5 tap settings can be set at the time of installation to deliver a more optimal supply to the site. Additionally, should a site's voltage profile change, tap settings can be adjusted when the transformer is powered down – such as at times of maintenance.

- ✔ No risk of system disturbance
- ✔ Can be implemented as one complete solution
- ✔ Cost effective combined solution
- ✔ Voltage management offers average additional consumption savings of around 7%
- ✔ Doesn't require additional equipment
- ✔ Doesn't add transmission losses
- ✔ Dynamic alongside changing demands
- ✔ A bespoke solution



A CONCEPT TO COMPLETION APPROACH

From understanding the unique requirements and challenges our customers face to ensuring that they receive the best possible solution that has no negative impact to the company or its operations. We understand the need for clear communication before, during and after an install and our team of experts is here to assist you every step of the way and ensure that tangible results are delivered.

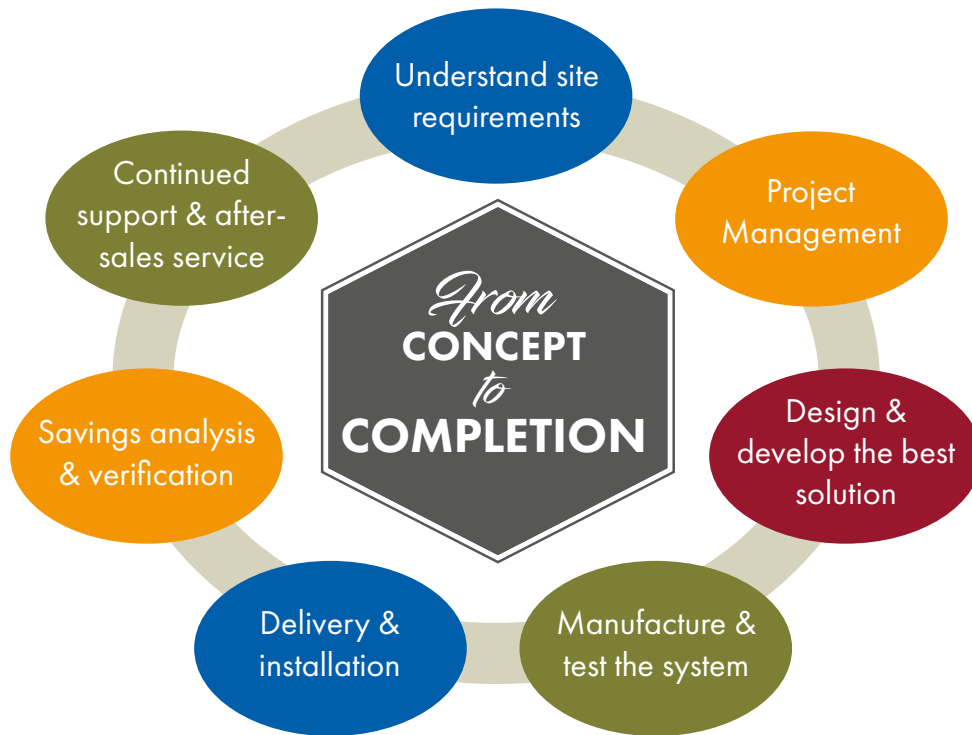

FLEXIBLE FINANCE OPTIONS

Powerstar offers its customers in the UK a range of energy efficiency financing options to allow for the flexible funding of transformers.

The flexible finance options are available on the full range of Powerstar products providing an added value solution and offering flexibility to your purchasing process, allowing organisations to choose from a range of repayment options to meet individual business needs.

ENERGY EFFICIENCY FINANCE PACKAGES INCLUDE:

- Hire purchase & leasing agreements
- Rental options

All finance options are subject to eligibility

To learn more about our finance options or discuss the best solution for your business, contact us today on **01142 576 200**

POWERSTAR SO-LO TECHNICAL INFORMATION

Powerstar Tier 1 ONAN Standard Amorphous Core Distribution Transformer Specification

Specification EN 60076 - Aluminium Windings

Primary 11,000 Volts complete with off load tap change switch @ +/- 2.5 & 5%

Secondary 400 Volts (417 Volts off load) vector group Dyn 11

ONAN Cooling - oil specification BS EN 60296 (formerly BS 148)





Primary connections - bushings in an air insulated HV mild steel box.

Secondary connections - LV monoblock including neutral point in an air cooled mild steel box





POWERSTAR SO-LO TYPICAL SPECIFICATION

KVA	No Load Loss	%Z	Dimensions	Weight
315	250W	4%	1,750mm L-R 1,685mm Deep 1,060mm High	2,100 kgs
500	350W	4%	1,870mm L-R 1,695mm Deep 1,200mm High	2,800 kgs
800	370W	4.50%	1,885mm L-R 1,860mm Deep 1,305mm High	3,600 kgs
1,000	400W	4.50%	1,950mm L-R 1,800mm Deep 1,440mm High	3,910 kgs
1,600	730W	4.50%	2,310mm L-R 2,085mm Deep 1,610mm High	4,500 kgs
2,000	750W	5%	2,505mm L-R 2,260mm Deep 1,815mm High	4,950 kgs
2,500	1,100W	5%	2,660mm L-R 2,420mm Deep 1,815mm High	5,800 kgs

As a bespoke solution, we manufacture each system to meet the customer's requirements. This can include the addition of components such as:

-  Winding temperature indicator (WTI)
-  Oil temperature indicator (OTI)
-  Marshalling box
-  Pressure relief device
-  Custom HV or LV boxes

We provide service plans to ensure the optimal running of systems, this can include:

-  Checking or changing of breather
-  Checking electrical connections for torque (subject to power off)
-  Checking and touch up of external paint work
-  Physical oil sample and DGA analysis (issue report)

EXAMPLE 800kVA POWERSTAR SO-LO DRAWING

Powerstar **SO-LO** is a bespoke solution and can be delivered in line with your priorities and requirements. Below is a drawing highlighting the typical dimensions for the following specification:

800kVA, Dyn11, 11kV – 433V

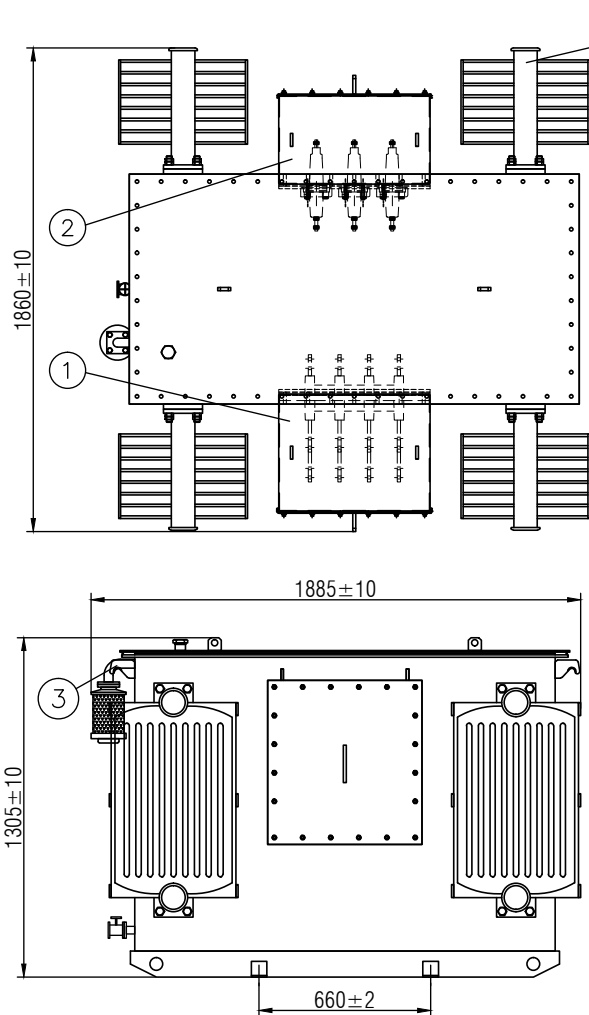

1. LV CABLE BOX
2. HV CABLE
3. MAINTANK LIFTS
4. PRESSURE RELIEF VALVE
5. OIL LEVEL GAUGE
6. OFF LOAD CHANGER
7. RATING AND DIAGRAM PLATE
8. OIL DRAIN VALVE
9. RADIATORS
10. SILICA GEL BREATHER
11. OIL FILLER CAP

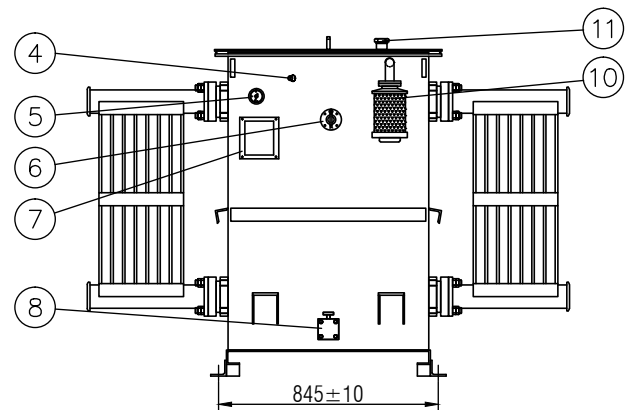

Delivering Powerstar **SO-LO** as a containerised solution

In addition to the above example of a free-standing design, Powerstar **SO-LO** can be delivered within a containerised solution, featuring a distribution transformer and HV/LV switchgear, which is an increasingly popular and economical approach to providing energy to locations such as construction sites.

Containerised solutions are exclusively delivered as a bespoke solution, ensuring it is entirely fit-for-purpose, and are ideal for businesses that require a mobile substation or have limited space on-site for dedicated HV infrastructure.

Powerstar's containerised solutions are compact and fabricated offsite to ensure a fast and effective supply to a site whilst minimising disruption to its operations. Because of this, they provide the perfect solution to the energy needs of building sites, sites which require additional capacity, or those that need to upgrade their power supply.

For more information about a bespoke containerised Powerstar **SO-LO** solution please contact us on **01142 576 200** to discuss your requirements with an expert member of the Powerstar team.



REMOTE MONITORING: A SMART APPROACH TO TRANSFORMERS

In a rapidly advancing technological world, why is your distribution transformer left in the dark?

Transformers are critical infrastructure for many companies yet they are not connected and online. Their health, performance and efficiency are typically unknown or reliant upon annual manual inspections of antiquated gauges/meters. What would be the added value to your operations? Longevity of equipment, your energy efficiency? Or even your bottom line if you could access this information from a single place remotely at any time?

SO-LO remote monitoring enables 24/7 visibility and understanding of how the equipment is operating, enabling issues to be identified before an event occurs whilst informing decisions on energy use and maintenance activities by providing comprehensive data. It can also help you to identify where efficiencies can be made to get the best return on your investment.

Developed with Industry 4.0 in mind, which is defined by McKinsey and Company as the next phase in the digitisation of the manufacturing sector, **SO-LO** remote monitoring provides intelligence including useful grid information, conditional performance data and energy efficiency reports.

THE BENEFITS OF REMOTE MONITORING

- Online oil analysis provides real-time critical information about the condition of the oil, reducing maintenance & inspection costs.
- Volts on each phase to give engineers visibility of the voltage on each phase.
- Phase to phase metrics to provide further insights of energy use to on-site engineers.
- Amps on each phase to provide details on the current load of each phase.
- Real power measured in kW per phase for greater visibility and understanding of the site's consumption for identifying inefficiencies.
- Power factor to allow engineers to identify poor power factor and areas for improvement.
- Temperature of core transformer for safety and to identify any issues caused if the transformer is running hot.
- Harmonic distortion to allow tracking of harmonics in order to prevent tripping of equipment, overheating or cables, damage to switchgear, and excessive energy use.
- Total system kVA to provide insights into energy that is being paid for but not utilised.
- Total system kWh to show total energy consumption of the site, to enable areas of further optimisation to be identified and allow reductions to be made.
- GPS location to allow for quick and easy identification of assets on larger sites

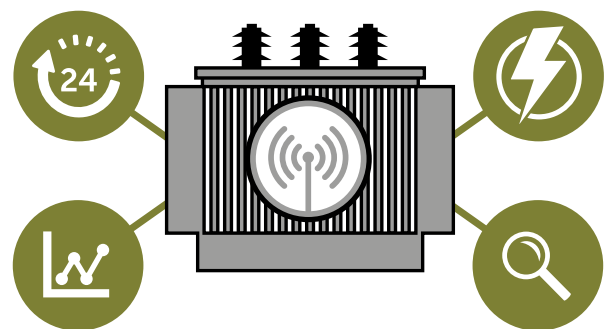

Join the smart revolution and allow **SO-LO** remote monitoring to bring your transformer into the 21st century and provide added value through insights that enable you to make informed decisions and enhance your operations.

OUR PROFICIENCY IS ENSURING YOUR EFFICIENCY

Learn more about the only UK manufactured super low loss amorphous core distribution transformer today and discover the benefits:



Significant energy cost savings over transformer lifetime



Greater supply efficiencies with a super low loss core



Simple HV infrastructure upgrade for enhanced energy consumption savings

UK MANUFACTURING

Powerstar **SO-LO** smart transformers are designed and manufactured in the UK. As a result our clients can be assured that the solutions we provide represent the most efficient and highest quality systems on the market, which are engineered to recognised international manufacturing standards. In addition, with full R&D, design, engineering, manufacturing and assembly facilities in-house we can offer our clients short lead times and a crucial differential of flexibility, as all our systems can be tailored to meet the unique requirements of the client, including designing bespoke engineered solutions to tackle whatever challenges our clients face.



POWERSTAR BUYBACK GUARANTEE

Sustainability is at the heart of our business, so with our range of Powerstar **SO-LO** smart transformers we guarantee to buy back and dispose of your old transformer to ensure an effective, risk free, and environmentally friendly solution that minimises disruption to your site's operation.

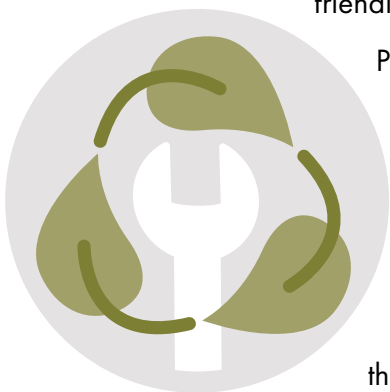

Powerstar is a registered ISO 14001 company, and as such we are committed to incorporating sustainable processes across all our business functions in order to manage and influence the positive environmental and social impact of our business activities. This extends to our commitment to continuously exceed our high standard of environmental excellence.

To achieve this, stringent sustainability principles are embedded within all our products and services including our relationship with ethical suppliers and within the communities in which we operate.

THE ONLY AMORPHOUS CORE DISTRIBUTION TRANSFORMER DESIGNED AND MANUFACTURED IN THE UK



INTRODUCING POWERSTAR SO-LO



Dr Alex Mardapittas discusses the benefits of Powerstar SO-LO



Powerstar SO-LO transformer



Super low amorphous core



Super low amorphous core



Dr Alex Mardapittas showcases the SO-LO remote monitoring capabilities



Inside Powerstar SO-LO

DISCOVER THE BENEFITS THAT AN AMORPHOUS CORE
DISTRIBUTION TRANSFORMER COMPLETE WITH REMOTE
MONITORING CAN DELIVER FOR YOUR BUSINESS BY
CONTACTING US TODAY



[/powerstar](#)



[@powerstarvo](#)



[/emspowerstar](#)



4 Cowley Way, Ecclesfield, Sheffield, S35 1QP
T: +44 (0)1142 576200 | E: info@powerstar.com

www.powerstar.com